

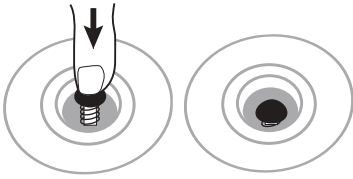

AIRLINE

How to pack

- 1** Deflate the board by pushing the pin down to lock it in the down position.



- 2** Fold the nose of the board to release the cable.

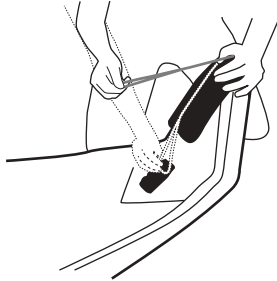

- 2** Remove the nose cone.

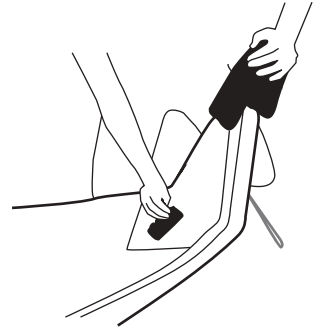

- 4** Start folding the board from the nose. And then from the tail.



- 5** Continue folding the board towards the standing tray.

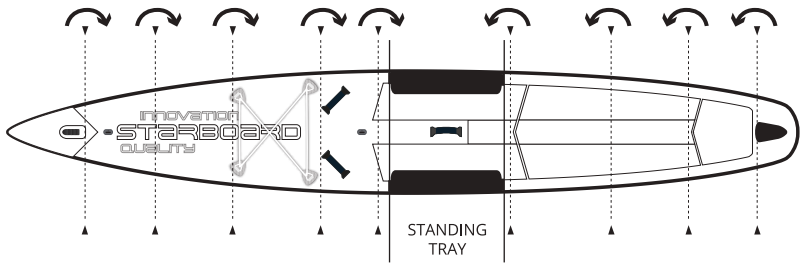

- 6** The final fold should have the fin box completely on top of the other folds.



- 7** Place the board in the bag with the fin box facing up.

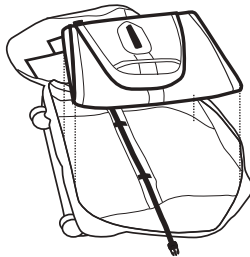

- 8** Secure your board with the compression belt.



- 9** Keep the small equipment in the pocket.

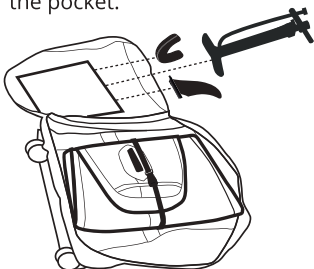

- 10** Close the bag with the zippers.



- 11** Connect the compression belt to reduce pressure on the zipper.





AIRLINE

How to set it up

- 1 Inflate the board up to 1 PSI.

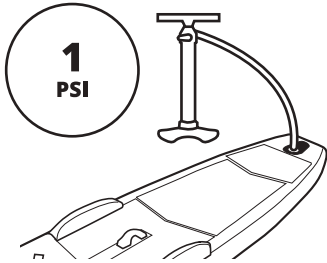

- 2 Place the Nose Cone on the nose of the board with the Tiki logo standing up.

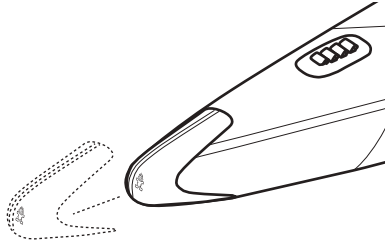

- 3 Pass the aramid cable along the groove line of the Nose Cone. Slightly bend the nose to allow the loop to lock on the hook. Make sure the loop is properly set in the hook before inflating.

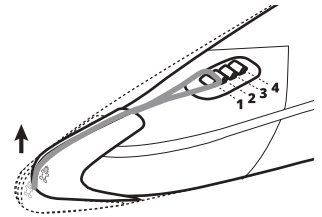

- 4 Inflate the board carefully to make sure the loop and the Nose Cone stay in a straight position. Do not exceed 18 PSI. The cable should be under full tension once inflated. If the tension is not enough, you can adjust the loop onto a different hook position. See the next step to do so.

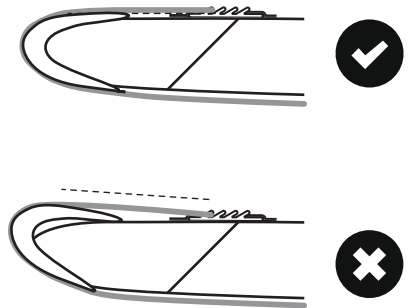
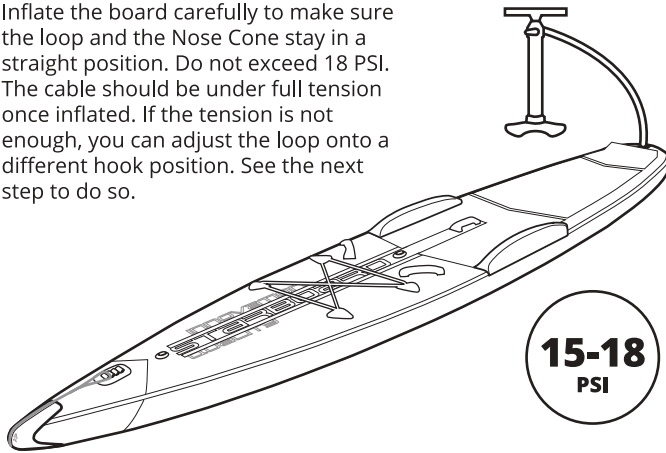

How to adjust the Airline tension, if needed.

- 1 Deflate the board by pushing the pin down to lock it in the **DOWN** position. Let the air out until the board can be bended, push the pin again to stop deflating and it will lock in the **UP** position.

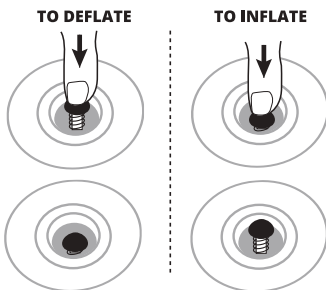

- 2 Slightly bend the nose of the board with the Nose Cone attached to lock the loop on the next hook slot. This will create more tension.

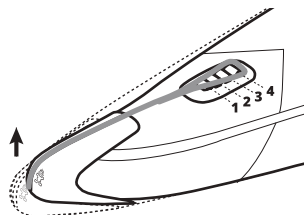

- 3 Inflate the board carefully while making sure the loop and the Nose Cone stay in a straight position.

